

SA 6 C

Dimensions

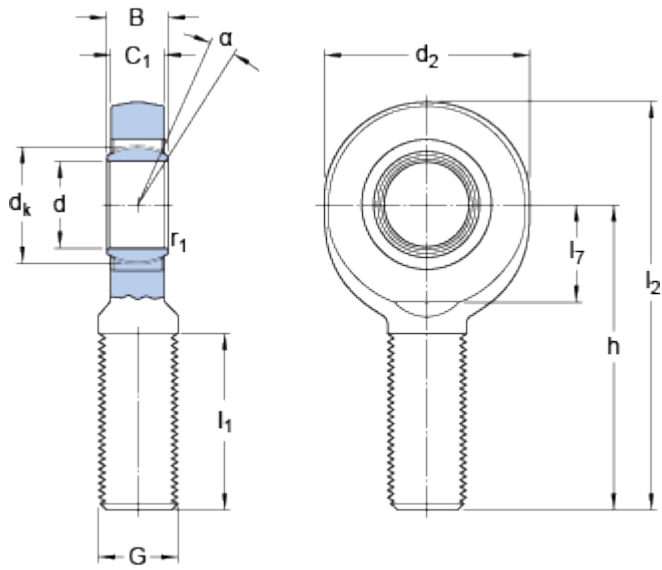

d		6	mm
d ₂	max.	22	mm
B		6	mm
G		M 6	
C ₁	max.	4.5	mm
h		36	mm
α		13	°
d _k		10	mm
l ₁	min.	16	mm
l ₂	max.	49	mm
l ₇	min.	10	mm
r ₁	min.	0.3	mm

Calculation data

Basic dynamic load rating	C	3.6	kN
Basic static load rating	C ₀	8.2	kN
Specific dynamic load factor	K	100	N/mm ²
Material constant	K _M	1400	

Mass

Mass rod end		0.017	kg
--------------	--	-------	----